

AC 24 V

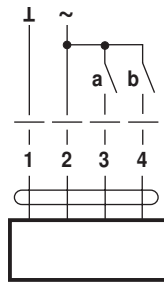

AVK24A-3

AC 230 V ⚠

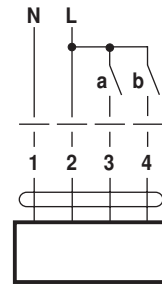

AVK230A-3

3 a	4 b		
		—	—

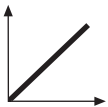

AC 24 V / DC 24 V

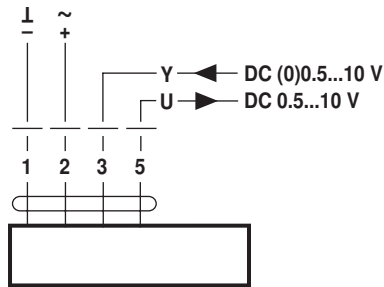

AVK24A-SZ

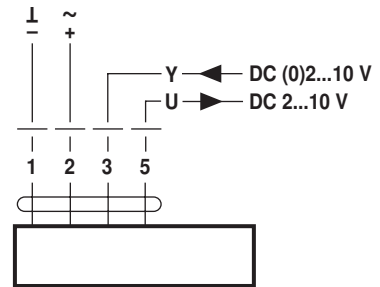

AVK24A-SR

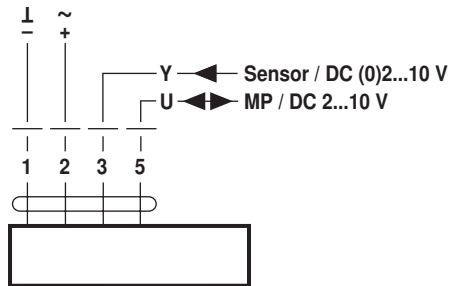

AVK24A-MP

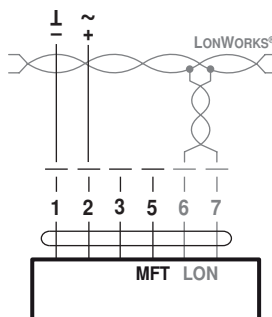
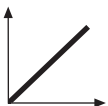

..VK24ALON

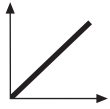

AC 24 V / DC 24 V

BACnet MS/TP / Modbus RTU

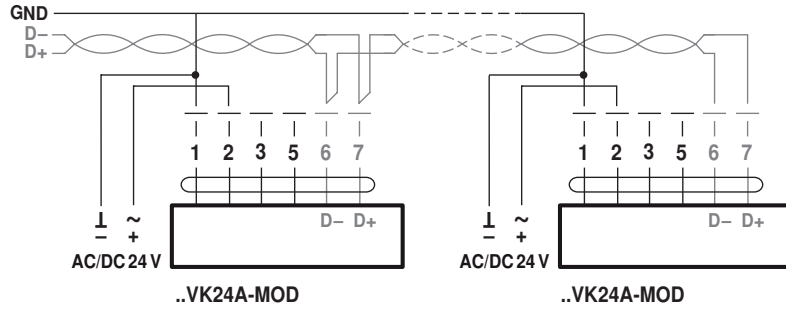

BACnet MS/TP / Modbus RTU / analog

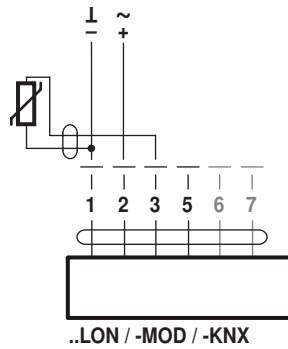
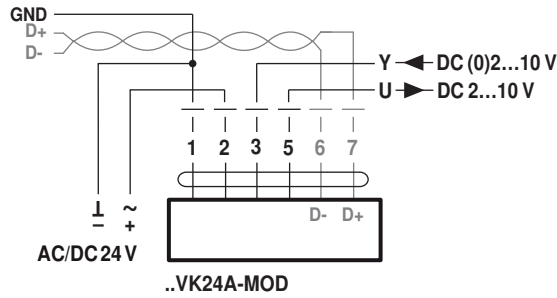

Ni1000	-28...+98°C	850...1600 Ω ²⁾
PT1000	-35...+155°C	850...1600 Ω ²⁾
NTC	-10...+160°C ¹⁾	200 Ω...60 kΩ ²⁾

